

# wellcare



## Hot & Cold Massage Gun

**USER MANUAL**

**Model Number FE-5856**



# Contents

- 03 Important Safety Instructions**
- 07 Product Overview**
- 08 Getting Started**
- 09 Operation**
- 11 Other Useful Information**
- 12 Specifications**

# Important Safety Instructions

## READ CAREFULLY AND KEEP FOR FUTURE REFERENCE

Read this manual thoroughly before first use, even if you are familiar with this type of product. The safety precautions enclosed herein reduce the risk of fire, electric shock and injury when correctly adhered to. Make sure you understand all instructions and warnings. Keep the manual in a safe place for future reference, along with any warranty information, your purchase receipt and the original packaging carton. If you sell or transfer ownership of this product, pass on these instructions to the new owner of the product.

**Always follow basic safety precautions and accident prevention measures, including the following:**

### Usage conditions and restrictions

- This product is intended for private use by adults only. It is not suitable for commercial or trade use. Do not use it for anything other than its intended purpose, and only use it as described in this manual.
- **Only use the device:**
  - on a dry surface of the body over clothing by lightly pressing and moving across the body for approximately 60 seconds per region.
  - on the body's soft tissue, as desired, without producing pain or discomfort — do not use it on the head or any hard or bony area of the body.
  - with the supplied applicators — chose the applicator that provides the best desired effect.
- Bruising can occur regardless of the control setting or pressure applied. Check treated areas frequently and immediately stop using the device at the first sign of pain or discomfort.
- Keep fingers, hair or any other body part away from the shaft and backside of the applicator as pinching may occur.
- Never insert any objects into the ventilation holes of the product.
- This product is NOT intended for use by persons (including children) with reduced physical, sensory or mental capabilities, or lack of experience and knowledge, unless they have been given supervision or instruction concerning use of the appliance by a person responsible for their safety.
- Supervise children to ensure they do not play with the product. Close supervision is necessary if the product is used by or near children.
- Do not expose the product to direct sunlight or place it near a heater or other heat source. Do not use it outdoors.
- Only use the supplied applicators. Do not use any attachment that is not supplied by the manufacturer.
- Do not use the product while driving, straight after a meal, when drunk, or if there is risk that you might fall asleep.

# Important Safety Instructions (Cont.)

## Health matters

This product is a non-professional appliance designed to provide a soothing massage. Do not use it as a substitute for medical attention.

- **CAUTION: Consult your doctor prior to using this product:**
  - if you have any concerns regarding your health, or suffer from an illness that may give you cause for concern
  - if you are pregnant
  - if you have a cardiac pacemaker, artificial joints or electronic implants
  - if you suffer from one or more of the following illnesses and complaints: circulation disorders, varicose veins, open wounds, bruises, broken skin, inflammation of the veins.
- **CAUTION: Do NOT use this product:**
  - to supplement or replace medical treatment — chronic complaints and symptoms may be made worse
  - on swollen or inflamed areas or skin eruptions
  - if you suffer from any physical ailment that would limit your capacity to operate the control

## Care, cleaning and storage

- Before cleaning or maintaining the device, make sure it is disconnected from the power socket.
- Only clean the housing with a soft, dry or slightly damp cloth. Do not use liquid or aerosol cleaners. Do not use solvent or oil-based cleaners.
- Do not use chemical, steel wool or abrasive cleaners to clean the outside of the massage seat as these chemicals may damage the finish.
- Store the appliance in a cool and dry indoor area, disconnected from the power supply and out of direct sunlight. Before prolonged storage, apply charge to bring the battery to about half charge. Prolonged storage of an empty battery may damage the battery. During prolonged storage, we recommend you use and recharge the appliance every three months.
- Do not use the product if it has been damaged or is not working properly.
- Do not attempt to repair, disassemble or modify the product; there are no user-serviceable parts inside. In case of damage, contact our after sales support centre.
- Improper installation or misuse may result in the risk of fire, electric shock and injury. We accept no responsibility for any eventual injury or damage caused by improper use or noncompliance with these instructions.
- Please dispose of the battery responsibly after the service life of the product.

# Important Safety Instructions (Cont.)

## Electrical safety (charging)

- **WARNING:** Only use the supplied charging cable to charge the appliance.
- **Voltage:** Before connecting, ensure that the electrical voltage and circuit frequency correspond to those indicated on the rating label.
- **Connection/disconnection:** To connect the battery charger, insert the power plug firmly into an appropriate mains socket. To disconnect, grip the power plug firmly and remove it from the outlet, do not pull on the cord.
- **Charging:** When charging the appliance, place it on a flat surface, away from hot surfaces and close to a power point so no one trips over the cord. Do not leave the appliance charging or operating unsupervised. Do not attempt to use the device while it is being charged.
- **Protect the power cord:** Do not kink, strain or damage the charger's power cord and protect it from sharp edges and heat. A damaged power cord must be replaced by the manufacturer, an authorised service centre or similarly qualified personnel in order to avoid a hazard. In case of damage, contact our after sales support centre for advice.
- **Protect from moisture:** To protect against electric shock, do not immerse the cord, plug or the device in water. Do not spill liquids into the device. Do not allow water to enter the ventilation holes of the device. Ensure your hands are dry before use.

## DANGER - to reduce the risk of electric shock

- DO NOT reach for an appliance that has fallen into water. Unplug it immediately.
- DO NOT use while bathing or in a shower.
- DO NOT place or store the appliance where it can fall or be pulled into a tub or sink.

## **WARNING - to reduce the risk of burns, electric shock, fire or injury to persons**

- An appliance should NEVER be left unattended when plugged in. Unplug from outlet when not in use, and before putting on or taking off parts or attachments.
- DO NOT operate where aerosol (spray) products are being used or where oxygen is being administered.
- DO NOT operate under a blanket or pillow. Excessive heating can occur and cause fire, electric shock, or injury to persons.
- DO NOT carry this appliance by the supply cord or use cord as a handle.
- NEVER operate the appliance with the air openings blocked. Keep the air openings free of lint, hair, and the like.
- NEVER operate on a soft surface such as a bed or couch where the air openings may be blocked.
- Not recommended for use by people with diabetes.
- NEVER cover the appliance when it is in operation.
- DO NOT use this product for more than 15 minutes at a time.
- Extensive use could lead to the product's excessive heating and shorter life. Should this occur, discontinue use and allow the unit to cool before operating.
- DO NOT use this product before bed. The massage has a stimulating effect and can delay sleep.
- NEVER use this product while in bed.
- This product should NEVER be used by any individual suffering from any physical ailment that would limit the user's capacity to operate the controls or who has sensory deficiencies in the lower half of their body.
- NEVER use this product in automobiles.
- This appliance is intended for household use only.

# Product Overview

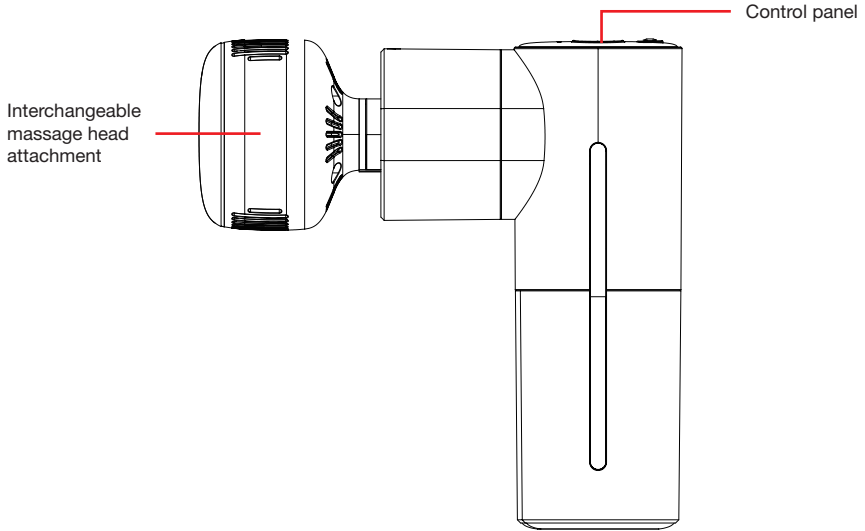

## Control Panel

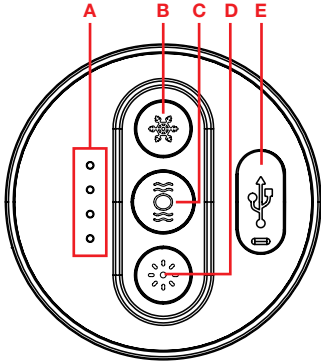

- A. Battery/power LED indicator
- B. Cold massage mode
- C. Massage on/off
- D. Hot massage mode
- E. USB-C port: insert the supplied USB charging cable and the other end to a power source to charge the device.

# Getting Started

## Before first use

- Unpack the product and accessories and ensure all parts of the product are undamaged and in good working order. Keep the original packaging carton and materials in a safe place. It will help prevent any damage if the product needs to be transported in the future, and you can use it to store the product when it is not in use. In the event that the packaging is to be disposed of, please recycle all packaging materials where possible.
- Plastic wrapping can be a suffocation hazard for babies and young children, so ensure all packaging materials are out of their reach and disposed of safely.
- Unwind the cord of the charging cable to its full length and inspect it for damage. Do not use the product if any part is damaged or not working properly. In case of damage, contact our after sales support line for advice.
- Read this manual to familiarise yourself with the product. Pay particular attention to the safety instructions on the previous pages.

## Charging the device

- Charge for 5 hours with the supplied USB charging cable before first use.
- The battery indicator on the device will flash during charging.
- Once the indicator stops flashing and lights up green, it indicates that the device is now fully charged.
- When the battery is low, please charge the device again.

## Battery indicator colour

- Green (4 lights are lit up) - battery is fully charged.
- Green (1 light is lit up) - battery is low.
- Green (1 light is flashing) - no battery - device will automatically turn off.

## Only use the device:

- On a dry surface of the body, over clothing, by lightly pressing and moving across the body for approximately 60 seconds per region
- On the body's soft tissue, as desired, without producing pain or discomfort — do not use it on the head or any hard or bony area of the body
- With the supplied applicators — chose the one that provides the best effect.

Bruising can occur regardless of the control setting or pressure applied. Check treated areas frequently and immediately stop using the device at the first sign of pain or discomfort.



# Operation

## Interchangeable head attachments



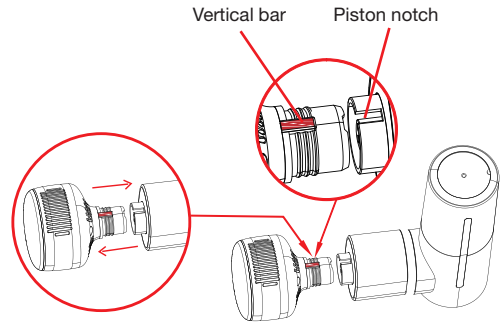
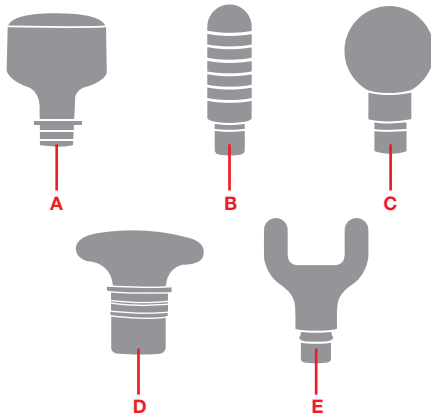









- The device comes with 5 interchangeable head attachments. To change head attachments, first make sure the device is switched off. Pull out the current head attachment and insert the desired head attachment.
- Note: for the hot & cold massage head, align the vertical bar of the head onto the piston notch (see below illustration).





- Attaching and detaching the hot & cold massage head. Ensure the vertical bar of the head is aligned to the piston notch.

- A. Hot & Cold massage head - relaxing whole body
- B. Cylindrical head - suitable for deep tissue
- C. Spherical head - suitable for larger muscle groups
- D. Flat head - suitable for chest, back and flat muscles with a wide surface area
- E. U-Shaped head - suitable for neck and spine

## Using the device

- When the device is off, press any button on the control panel to display the battery status. The battery/power LED indicator will light up corresponding to the current battery status.
- Press and hold the  button for 3 seconds to start the massage. The default intensity is set to level 1. The battery/power LED indicator will light up blue. Press the  button again to increase the intensity to level 2, the LED indicator will now light up purple. Press the  button again to increase the intensity to level 3, the LED indicator will now light up red. To stop the massage and turn off the device, press and hold the  button for 3 seconds.
- Press and hold the  button for 3 seconds to start the heat massage mode. The default heat setting is set to level 1 (35°C). The battery/power LED indicator will light up blue. Press the  button again to increase the heat setting to level 2 (40°C), the LED indicator will now light up purple. Press the  button again to increase the heat setting to level 3 (45°C), the LED indicator will now light up red. To stop the heat massage and turn off the device, press and hold the  button for 3 seconds.
- Press and hold the  button for 3 seconds to start the cold massage mode. The default cold setting is set to level 1 (20°C). The battery/power LED indicator will light up blue. Press the  button again to increase the cold setting to level 2 (15°C), the LED indicator will now light up purple. Press the  button again to increase the cold setting to level 3 (10°C), the LED indicator will now light up purple. To stop the cold massage and turn off the device, press and hold the  button for 3 seconds.

## Notes

- You can switch between the massage modes when the device is on by pressing the  /  /  buttons.
- **For the hot and cold massage, the hot & cold massage head must be attached, as the other massage heads do not support this function.**

# Other Useful Information

## Troubleshooting

If the device does not work, check and ensure that it is fully charged. Also check and ensure that the massage head is properly inserted into the device. If all connections are correct and the product is still not working, please call our after sales support centre. Do not attempt to open and repair the product yourself.

Another reason for the device to switch off automatically are the in-built safety features. One safety mechanism switches the motor off automatically after 15 minutes' continuous operation. Furthermore, an overheat protection mechanism switches the motor off to prevent overheating after extended use. In such a case, wait 30 minutes for the device to cool before reuse.

## Cleaning and care

- Before cleaning the device, make sure it is disconnected from the charging stand and power source.
- Use a soft, slightly damp sponge or cloth to wipe the device clean. Dry thoroughly using a dry cloth.
- Do not immerse the device in water or liquid or allow it to become wet.

## Storage

- After use, wipe the device clean with a damp cloth.
- Store the device and the interchangeable massage heads in the original box to keep dust accumulation to a minimum.

## Service and repair

- The product contains no user-serviceable parts. Do not attempt to take it apart, repair or modify it.
- Do not operate the product if it is damaged or working abnormally. Contact our after sales support centre if a service is required.

## Compliance

This appliance has been fully tested and meets all requirements as set out by standards AS/NZS 60335.2.32 for electrical safety.



The RCM Mark (Regulatory Compliance Mark) indicates that the product complies with the relevant guidelines of the ACMA as well as corresponding government requirements for the safety of electrical devices.

# Specifications

Battery capacity	Li-ion 10.8V, 2500 mAh
Charging voltage and current	5V --- 2A
Max. power consumption	35W Max.
Amplitude	10mm
Speed modes	Level 1: 1800RPM, Level 2: 2000RPM, Level 3: 2300RPM
Temperature value	Heating: Level 1: 35°C, Level 2: 40°C, Level 3: 45°C Cooling: Level 1: 20°C, Level 2: 15°C, Level 3: 10°C
Charging time	5-6 hours
Working time	1.5-4 hours (working time varies on selected massage mode and intensity level)
Auto timer	15 minutes
Weight (device only)	625 g
Dimensions (W x H x D) (mm)	156 x 151 x 59

For Technical and Warranty Support

1300 886 649

[tempo.org/support](http://tempo.org/support)

Distributed by Tempo (Aust) Pty Ltd,  
PO Box132, Frenchs Forest NSW 1640

## Responsible disposal

**WARNING!** This product contains a rechargeable lithium-ion battery. Never throw the appliance into a fire and do not subject it to high temperatures. There is a risk of explosion!

At the end of its working life, do not throw this appliance out with your household rubbish. Electrical and electronic products contain substances that can have a detrimental effect on the environment and human health if disposed of inappropriately.

Cut the power cord of the battery charger and remove the lithium-ion battery pack from the appliance before disposal. Dispose of the appliance and the battery pack responsibly, observing any local regulations regarding the disposal of consumer goods and batteries. Contact your local authorities for advice on battery disposal and recycling facilities for electrical consumer goods.

# Notes

# Notes

# Notes



## **Warranty returns**

Should you for any reason need to return this product for a warranty claim, make sure to include all accessories with the product.

## **Product does not work?**

If you encounter problems with this product, or if it fails to perform to your expectations, make sure to contact our After Sales Support Centre on (AU) 1300 886 649 or (NZ) 0800 836 761 for advice.

Distributed by Tempo (Aust) Pty Ltd ABN 70 106 100 252

PO BOX 132 Frenchs Forest, Australia NSW 1640

Customer Helpline:

(AU) 1300 886 649 (NZ) 0800 836 761

Email: [tempo.org/support](mailto:tempo.org/support)